

White Paper

Measuring Switch-mode Power Amplifiers

By Bruce Hofer

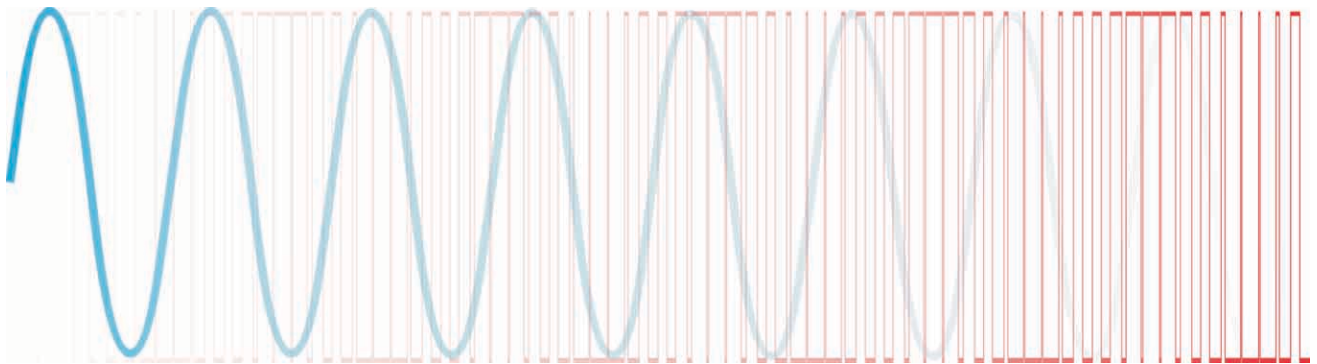

Audio 
precision®

October 2003

Measuring Switch-mode Power Amplifiers

Table of Contents

By Bruce Hofer

1.0 Introduction	3
1.1 Switch-Mode Amplifier Review	3
1.2 The Need for an External Passive Filter	3
1.3 The Audio Precision AUX-0025 Filter Accessory	4
2.0 Noise Measurements	5
2.1 Hum-Hiss Ratio	6
2.2 FFT Noise Measurements	6
3.0 THD+N Measurements	7
3.1 THD+N Versus Amplitude	8
3.2 THD+N Versus Frequency	8
3.3 Maximum Output Power	9
3.4 Dynamic Headroom	9
3.5 FFT Analysis of Harmonic Distortion	9
3.6 THD versus THD+N	10
4.0 Intermodulation Distortion Measurements	10
4.1 SMPTE or SMPTE/DIN IMD Measurements	11
4.2 Twin Tone IMD Measurements	11
4.3 Dynamic or Transient Intermodulation (DIM or TIM) Testing	12
5.0 Frequency Response and Phase Measurements	12
6.0 Crosstalk Measurements	13
7.0 Damping Factor Measurements	13
8.0 Supply Rejection Measurements	14
9.0 Efficiency Measurements	14
Summary	15
Acknowledgements	15
Useful Resources	16
About the author	16

1.0 Introduction

Switch-mode audio power amplifiers are becoming increasingly popular due to their smaller size, lower weight, and improved efficiency. Their advantages are obvious in low power battery operated personal audio players and laptop computers. However they are also progressively displacing more traditional linear designs in mainstream applications such as home entertainment systems, automotive sound systems, and professional installations where high quality audio is important.

Measuring the performance of switch-mode amplifiers presents some new and unique challenges. They inherently generate ultra-sonic artifacts and spurious signals with slew rates that can provoke non-linear behavior within the input stages of high quality audio test and measurement equipment. Absolutely worthless and inaccurate results can result unless effective measures are taken to prevent this non-linear behavior.

1.1 Switch-Mode Amplifier Review

Switch-mode amplifiers operate by using the output power devices as *switches*. Power amplification is accomplished by modulating the switching duty cycle of semiconductors (or vacuum tubes) as they alternate between high conduction and off states. Subtle differences in topology and how the switches are modulated has led to a plethora of amplifier classifications such as “Class D”, “Class T”, “Switching”, and even “Digital” (although this is somewhat inaccurate). Other trademarked names are also being used. The term “switch-mode” will be used throughout this discussion to refer to all types.

Because switch-mode amplifiers operate by switching the output between power supply rails, the raw time domain output signal is not a linear replica of its input. It contains considerable amounts of high frequency energy in the form of pulses and fast slewing edges. In the frequency domain, this signal can be separated into two regions. Within the intended pass-band the output signal is a reasonably amplified version of the input. Beyond the pass-band, the output signal contains strong spectral components at the switching frequency and its harmonics. In some designs the switching frequency may be purposefully varied to spread the high frequency energy into a more noise like spectrum.

In all cases the switching frequency must be sufficiently high to insure feedback stability of the amplifier, and to prevent modulation sidebands of the switching frequency from folding down below the upper end of the desired

audio pass-band. These constraints plus other practical design considerations usually require the switching frequency to be many times the maximum intended audio signal bandwidth. Switching frequencies of 250 kHz to 750 kHz are commonly used in full range 20 kHz audio amplifiers.

Switch-mode amplifiers often include an output LC low pass filter. The LC filter prevents power from being wasted due to the switching artifacts. The LC filter also prevents the amplifier from becoming an unlicensed transmitter of AM band energy since the loudspeaker wires will act as antennae. This is a formidable task because real LC filters lose their effectiveness above a certain frequency. All inductors have a parallel capacitance thus exhibiting self resonance. Capacitors also have both series parasitic resistance and inductance that limit the filter’s attenuation at high frequencies. Amplifier designers must often resort to controlled risetime switching circuits and other clever design techniques to limit the high frequency content in the switched output signal *before* it is filtered.

The LC filter additionally serves to prevent several potentially nasty problems when driving acoustic transducers. Switching artifacts could easily cause over-dissipation in tweeters and crossover elements unless they are significantly attenuated. Asymmetric forms of non-linearity within loudspeakers and crossover elements also raise the possibility of intermodulation distortion (IMD) products appearing within the audio band. Inductors used in the crossover networks of many inexpensive loudspeaker systems are often very non-linear. *[The author believes more research is necessary into the possible interaction of ultra-sonic interference with the non-linear ferromagnetic materials used in loudspeaker construction.]*

1.2 The Need for an External Passive Filter When Making Measurements

All commercial audio analyzers employ precision low noise and distortion operational amplifiers (op-amps) in their input and signal processing stages. These devices have typical slew rate capabilities of only 5-10 V/ μ sec compared to the *thousands* of V/ μ sec that can be present in the *unfiltered* output of a switch-mode amplifier. Connecting an audio analyzer directly to the unfiltered output of a switch-mode amplifier is a recipe for measurement disaster! Once the input stage of the analyzer is provoked into non-linear behavior by fast slewing signal components, all subsequent measurements will be invalid.

The inherent input slew rate susceptibility of audio analyzers is *not* the result of poor design. Mother Nature confounds us with practical tradeoffs between fast response and precision. Within the current state-of-the-art, it is simply not possible to design a high impedance analog input stage having audio-worthy distortion and noise performance without incurring a practical slew rate limitation. The input stages of oscilloscopes and lab-grade DVM's may appear to contradict this statement. However, and with all due respects, the residual distortion and noise performance of these types of instruments is typically orders of magnitude worse than a low-end audio analyzer.

- **Audio analyzers should not be expected to respond linearly to analog signals containing gross amounts of fast slewing pulses or high frequency energy.**

The output LC filters contained in most switch-mode amplifiers vary greatly in their effectiveness in removing fast slewing artifacts. Some do an admirable job. Others do not reduce the fast slewing signal components to the point where an audio analyzer is totally free of non-linear effects. This can be especially true when measuring low level output signals or noise because the high frequency switching artifacts tend to be more constant in amplitude. *The only reliable solution to insure measurement validity is to introduce a passive low pass filter between the output of the switch-mode amplifier and the inputs of the audio analyzer.* Active filter designs will not work for the exact same reason audio analyzers are susceptible in the first place!

The simplest passive filter design is the RC network. Because the output impedance of power amplifiers is very low within the audio band, the input impedance of the passive filter can be much lower than would otherwise be acceptable for the input of the audio analyzer. It only needs to be large in comparison to a 2Ω - 8Ω test load. Richard Palmer of Texas Instruments has suggested values of 100Ω & $56nF$, or $1k\Omega$ & $5.6nF$ in his very well written application note titled *Guidelines for Measuring Audio Power Amplifier Performance*. It covers many of the same topics addressed in this discussion.

Unfortunately, the performance tradeoffs of a single-stage RC filter are not very good. The RC filter values described above give a significant 19 dB of attenuation for a 250 kHz switching artifact, but at the price of 1.75 dB roll off at 20 kHz (-3 dB at 28.4 kHz). This magnitude of response error will cause noise and distortion measurements to be lower than they actually are. It will also prevent the direct measurement of the amplifier's frequency response without compensating for the RC filter's roll off characteristic. As a point of reference, an RC filter must have a -3 dB point above 131 kHz to keep its response error below 0.1 dB at 20 kHz.

A multiple stage LCR passive filter is much more desirable for this application. A single stage filter may not give sufficient attenuation of all switching artifacts due to limitations of inductor self resonance and capacitor series resistance (ESR) and inductance (ESL). The LCR filter

topology must be carefully chosen so that its input impedance does not become purely capacitive at high frequencies. This could cause excessive shunting currents to be drawn from the amplifier under test at its switching frequency, thus upsetting measurements of efficiency. Within the audio band the input impedance of the filter must also be sufficiently high in comparison to a typical 2Ω to 8Ω resistive test load so that it does not absorb significant amounts of signal power.

LCR filter inductors and capacitors must be extremely linear to prevent the unwanted introduction of harmonic and intermodulation distortion products. Air core inductors are mandatory—iron and ferrite core designs simply will not give satisfactory performance. Figure 1 shows the effect of inductor type on filter distortion in response to a twin tone test signal of 18 kHz and 20 kHz. The red trace resulted from the use of an inexpensive off-the-shelf ferrite core inductor. The blue trace shows the same filter with custom air core inductors of the same value.

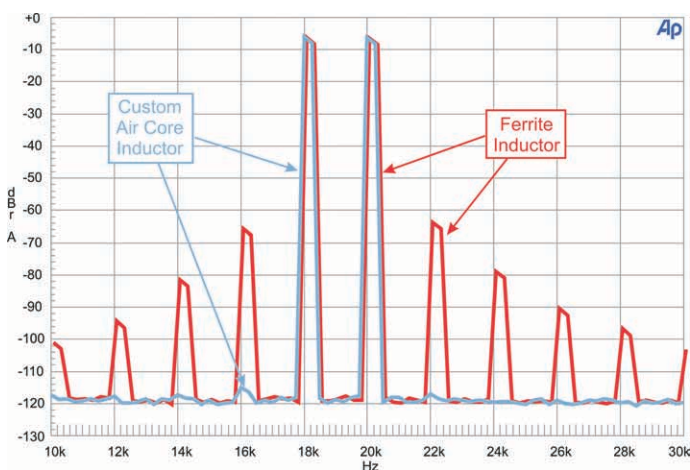

Figure 1. The effect of inductor core material on filter distortion. The red curve shows distortion with a typical ferrite core design. The blue curve shows virtually no filter distortion using a custom air core design.

1.3 The Audio Precision AUX-0025 Filter Accessory

The Audio Precision AUX-0025 filter accessory was designed to meet the demanding needs of measuring switch-mode amplifiers. It is a dual channel, passive, multi-stage LCR filter providing >50 dB attenuation from 250 kHz-20 MHz, ± 0.05 dB flatness over the 20 kHz audio



Figure 2 Audio Precision AUX-0025 Switching Amplifier Measurement .Filter.

pass band, and only 0.05 dB of insertion loss when connected to an analyzer with a 100 k Ω input impedance. The AUX-0025 also features vanishing low distortion so it will pass audio signals with negligible degradation.

Figures 3 and 4 show typical pass-band and attenuation curves. Each side of both inputs is filtered with respect of ground so that the stop band attenuation characteristic applies to both differential and common mode signals.

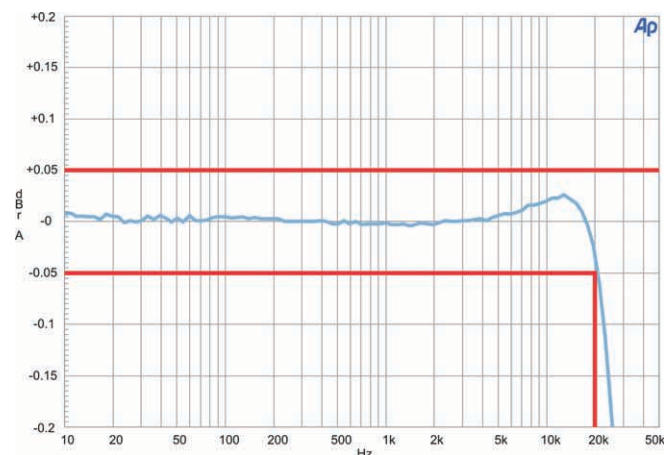

Figure 3. Typical pass-band response of the Audio Precision AUX-0025.

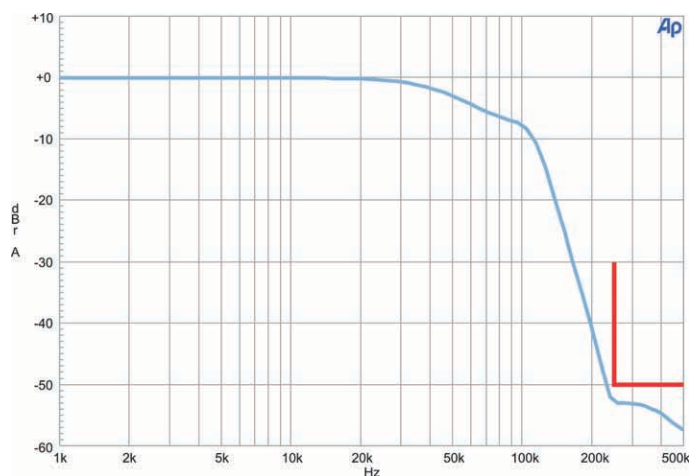

Figure 4. Typical high frequency attenuation characteristic of the Audio Precision AUX-0025. The response above 500 kHz is typically >50 dB to at least 20 MHz.

The input impedance of the AUX-0025 can be modeled as a 10 nF capacitor in series with 500 Ω (each side of the input to ground) with reasonable accuracy up to about 30 kHz. At higher frequencies, the 10 nF reactive component will vary somewhat as resonances of the internal LC filter stages are reflected back to the input. The equivalent series input resistor limits energy absorption of the switching components of the amplifier's output, and guarantees the input impedance will never be less than 500 Ω . It also minimizes complex interactions with the LC filters that may be present behind the outputs of many switch-mode amplifier designs.

Compared to a typical 2 Ω to 8 Ω test load and the very low output impedance of the power amplifier, the loading effects of the AUX-0025 are practically negligible. The pass band response characteristic remains valid with source impedances up to 2 Ω . Usage with higher source impedances is possible, but it will cause additional filter roll off at 20 kHz. The AUX-0025 should not be connected to typical line level audio outputs.

Figure 5 shows the recommended connection of the AUX-0025 in relation to the test load, the amplifier under test, and the audio analyzer. It is compatible with both single ended or bridged amplifier output configurations, and with audio analyzers having either unbalanced or balanced inputs. Please note that the AUX-0025 was not designed to pass high power, high current signals *through* its input connectors.

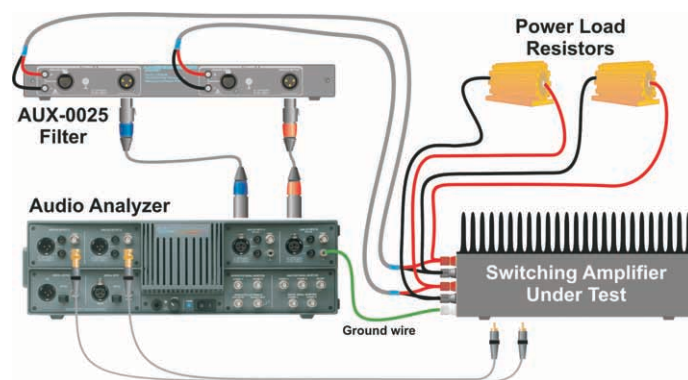

Figure 5. Recommended test setup using the AUX-0025. Note that the connections to the load are independent of the connections to the filter and analyzer.

To avoid permanent damage, DO NOT connect the test load to the banana jack inputs of the AUX-0025 if the XLR inputs are used!

Switch-mode amplifiers tend to have very noisy grounds that will impose unwanted common mode potentials to both the amplifier and analyzer input circuits. These can seriously limit the accuracy of audio measurements at low levels. Whenever possible, connect a *short*, multi-strand bonding wire directly between the ground of the amplifier under test and the analyzer chassis. If shielded cables are used to connect the inputs of the AUX-0025 to the test load, leave the shields unconnected at the test load end.

2.0 Noise Measurements

Residual noise is a good place to start a comprehensive study of switch-mode amplifier performance. Residual noise will limit the performance of many other characteristics such as THD+N, crosstalk, power supply rejection ratio, etc. So it is desirable to have some knowledge of noise performance to properly interpret other measurements.

Amplifier noise specifications are notoriously difficult to compare since there are so many different definitions for the word “noise”. *Unweighted* noise will always depend upon the measurement bandwidth. If the noise is spectrally flat or “white” in nature, it will be proportional to the square root of the measurement bandwidth. For every factor of 2 increase in measurement bandwidth, noise will theoretically increase by a factor of 1.414 or 3 dB. It is common practice to use either 20 kHz or 22 kHz for unweighted noise measurements. The 10% difference in these two bandwidths has only a negligible 5% impact on a typical noise measurement. Some designers still like to measure noise over a much wider bandwidth such as 80 kHz or even 500 kHz, however this is becoming less and less common.

Weighted noise measurements restrict the bandwidth even more and contour it based upon various models of the ear’s sensitivity to low level sounds. They give lower figures than unweighted measurements, thus they tend to be the more popular with marketing departments and advertisement writers. Figure 6 shows a comparison of the most popular noise weighting curves.

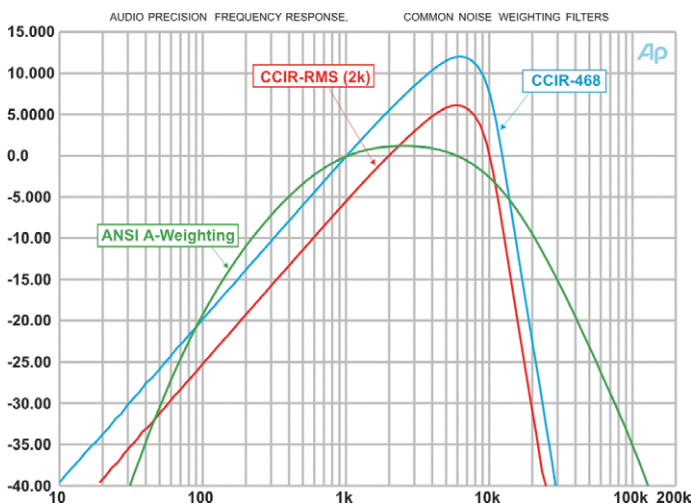

Figure 6. Popular noise weighting curves. The “A” weighting curve with rms detection is most commonly used in North America and Japan while the “CCIR-468” curve with quasi-peak detection is preferred in Europe. The “CCIR-RMS” curve is a relatively new variant.

To perform a noise measurement the amplifier inputs must be connected to external terminations, typically 600Ω, and the gain controls set to maximum (if present). Noise measurements are not valid if the inputs are left open, or shorted. The terminations should have no intrinsic noise of their own other than unavoidable thermal or Johnson noise. Amplifier noise is usually reported as a single figure per output channel, typically in Volts, dBu, or sometimes dB below the maximum rated output. Noise can also be expressed as an equivalent input noise voltage by dividing the measured output reading by the gain of the amplifier. This approach allows a more fair comparison between amplifiers having different voltage gains.

Historically, audio analyzers have employed bandwidth limiting and weighting filters with a 3 to 6 pole (18 to 36 dB per octave) roll-off characteristic. These types of filters yield

noise measurements that deviate only slightly from theoretical ideals provided the noise signal characteristic is spectrally flat or “white”. Unfortunately we now live in a world full of over-sampled noise shaping from sigma-delta converters and high frequency artifacts from switch-mode amplifiers. The word “audio” has suddenly expanded to include signals that can contain potentially gross amounts of out-of-band energy and noise whose spectrum is anything but white. The relatively “soft” un-weighting and weighting filters that once proved adequate for many decades of audio measurements will no longer give satisfactory results. Inadequate rejection of out-of-band interference will cause measurement errors, confusing reading differences between analyzers from different manufacturer, and even reading differences from among models of the same manufacturer.)

The Audio Engineering Society (AES) recognized this problem in the early 1990s as it relates to the testing of D-A converters. The resulting AES17 standard recommends the use of a very sharp bandwidth-limiting characteristic. Figures 7 and 8 show the 20 kHz implementation in the Audio Precision “S2-AES17” filter option for its premier System Two, Cascade, and AP2700 families of instruments. Audio Precision strongly advocates the use of this filter when testing switch-mode amplifiers and sigma-delta DACs.

NOTE: The AES17 filter option should not be confused with the AUX-0025 input filter accessory. Both are essential when testing switch-mode amplifiers. The AES17 filter implements the extremely sharp bandwidth limit characteristic late in the measurement path to provide attenuation of the analyzer’s internal sources of noise. The external AUX-0025 prevents input stage non-linearity that can be caused by the extremely fast slewing edges in the switch-mode amplifier output signal.

2.1 Hum-Hiss Ratio

The “hum-hiss” ratio is a quick diagnostic measurement to assess the relative audibility of ac mains related “hum” products versus random noise “hiss” in the amplifier’s output. Two unweighted (20 kHz or 22 kHz bandwidth limited) noise measurements are taken with and without a 400 Hz high pass filter. If the ratio of the two readings is greater than about 0.5 dB, “hum” (or “buzz” depending upon the spectral content) is likely to be perceived as the more annoying background limitation. Ratios below 0.5 dB usually indicate that “hiss” will be the more likely subjective limitation.

2.2 FFT Noise Measurements

The FFT provides a convenient way to examine the spectrum of noise to see what components are influencing or limiting performance. The rms amplitude of highly correlated components such as hum and discrete tones can be read directly from the spectral display. The window function of the FFT process imparts an amplitude error depending upon how much the signal frequency deviates from the exact center of a given FFT bin. This error can be significant for some window selections (for example, up to

1.5 dB with the Hann window), so beware when making comparisons to spectra obtained from different analyzers using different sample rates, bin widths, and window selections. The most accurate measurements of discrete component amplitudes are achieved using the “Flat-Top” window (worst case window amplitude error <0.02 dB).

Measuring uncorrelated or random noise with the FFT is a bit more complicated. The noise amplitude measured in any given FFT bin is a function of both the bin width and the FFT window function. Windowing inherently causes energy to spill or smear into adjacent bins. Thus the noise amplitude within each bin is really a complex summation of the noise in surrounding and closely adjacent bins. A simple rms summation of the amplitudes in all relevant FFT bins over a specified bandwidth will give a numerical result that is too high by the window noise “scaling” factor. The following table lists some of the more common FFT windows and their respective noise scaling factors.

Window Type	Noise Factor
None (Rectangular)	1.000 (0.00 dB)
Hamming	1.1674 (1.34 dB)
Hann	1.2247 (1.76 dB)
BH-4	1.4158 (3.02 dB)
Gaussian	1.4884 (3.45 dB)
Rife-Vincent-4	1.5199 (3.63 dB)
Rife-Vincent-5	1.6207 (4.19 dB)
AP Equi-Ripple	1.6223 (4.20 dB)
Flat-Top	1.9550 (5.82 dB)

For example, suppose a suitably averaged FFT display of an amplifier’s noise spectrum shows about -140 dBV (0.100 μVrms or 100 nVrms) in each FFT bin. Furthermore suppose the FFT length is 16384 points performed with a sample rate of 65.536 kHz using the AP “Equi-Ripple” window (noise scaling factor = 1.6223).

First calculate the FFT bin width:

$$\text{Bin Width} = \frac{65536 \text{ Hz}}{16384} = 4.00 \text{ Hz}$$

Then calculate the true noise “density” with each bin:

$$\text{Noise density} = \frac{100 \text{ nV} / \sqrt{(4 \text{ Hz})}}{\text{window.scaling.factor}} = 30.82 \text{ nV} / \sqrt{\text{Hz}}$$

An equivalent noise voltage measurement over a 20 kHz bandwidth would be:

$$\begin{aligned} \text{Noise voltage} &= 30.82 \text{ nV} \sqrt{\text{Hz}} \cdot \sqrt{20,000 \text{ Hz}} \\ &= 4.36 \mu \text{Vrms} (-107.2 \text{ dBV}) \end{aligned}$$

The above example assumed that the noise characteristic was equal at all frequencies or “white”. This is generally true of resistor thermal noise. Semiconductor

noise can be quite different often showing increases at low frequencies (“1/f” noise). Other factors can cause the noise density to increase at high frequencies. Significant departures from a flat or white noise characteristic will make the correlation of FFT displays with unweighted measurements more difficult.

3.0 THD+N Measurements

Total Harmonic Distortion and Noise (THD+N) is one of the most useful measurements of amplifier performance because it captures so many common forms of imperfection. The amplifier under test is driven with an ultra-low distortion sine wave, typically 1 kHz. The output of the amplifier is connected to a test load and audio analyzer that contains a notch filter to remove the sine wave signal. The left over signal following the notch filter contains harmonic distortion products, noise, hum, and other interfering signals that were introduced by the amplifier. Thus the name “THD+N” suggests its sensitivity to both distortion and noise.

Like noise, measurement bandwidth must be carefully chosen and specified for repeatable or comparable THD+N results. Switch-mode amplifiers inherently add significant signal energy above the audio band, especially at their switching frequency and its harmonics. Because the situation is not unlike the measurement of THD+N on over-sampled, sigma-delta D/A converters with large amounts of out-of-band signals (sometimes much larger than the audio band signal itself), Audio Precision recommends the use of its “S-AES17” option for making measurements. Figures 7 and 8 show the typical pass-band and stop-band response characteristics of this filter.

THD+N can vary significantly with both signal amplitude and signal frequency. Single point specifications or comparisons can be extremely misleading since manufacturers will naturally select the best operating conditions for their respective amplifiers. THD+N should be reported as a series of graphs showing its dependence upon both amplitude and frequency.

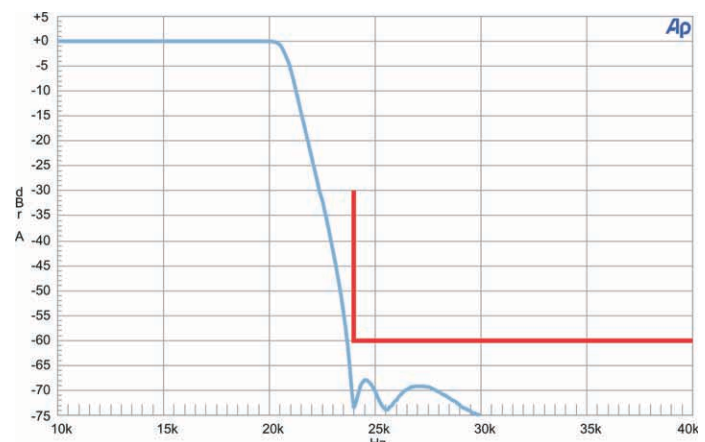

Figure 7. Typical roll-off characteristics of the Audio Precision S2-AES17 option filter

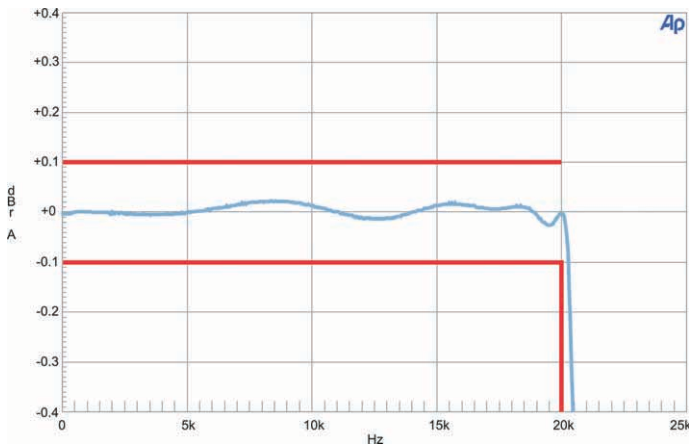

Figure 8. Typical pass-band characteristics of the Audio Precision S2-AES17 option filter

3.1 THD+N Versus Amplitude

The most common sweep of amplifier THD+N is usually done with a 1 kHz test signal. Figure 9 shows a typical graph demonstrating the two limiting aspects of amplifier performance. The abrupt and steep increase in 1 kHz THD+N above a certain power level is caused by clipping. At low power levels THD+N, when expressed in % or dB, also increases due to the fixed noise floor of the amplifier.

THD+N versus amplitude should be explored at several test frequencies. Using a lower test signal frequency such as 20 Hz to 50 Hz can reveal thermally related imperfections in the amplifier. The self heating effects within gain setting resistors and other devices can show up as increased odd order distortion (especially third harmonic or 3HD) compared to THD performance at mid-band. Using a higher test signal frequency often shows increased distortion because of lower feedback factors, non-linear junction

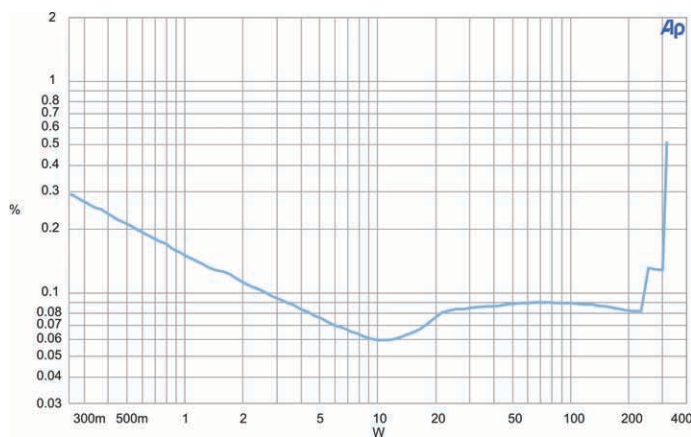

Figure 9. Sweep of THD+N (%) versus Amplitude at 1 kHz for a typical switch-mode amplifier. The rapid increase in readings at high amplitudes is caused by clipping while the increase in readings at low amplitudes is caused by the noise floor of the amplifier.

capacitance effects, and charge storage effects in power output devices. However measuring THD+N with a test signal frequency above about 20% of the measurement bandwidth is subject to the potential error of significant harmonics being rejected.

3.2 THD+N Versus Frequency

THD+N can also be explored versus frequency at a given signal level. Figure 10 shows a typical graph with the test signal swept from 10 kHz to 20 Hz. The overall shape of the curve shows the frequency dependence of distortion since all the other imperfections such as hum and noise remain relatively constant. An increase with decreasing frequency usually indicates a thermal non-linearity mechanism, or perhaps distortion contributed by coupling capacitors having a voltage coefficient. An increase in THD+N with frequency may result from decreasing feedback and a fixed non-linearity in the output device pulse width modulator. These explanations are illustrative only, and not meant to be an exhaustive discourse of all possible sources of amplifier distortion.

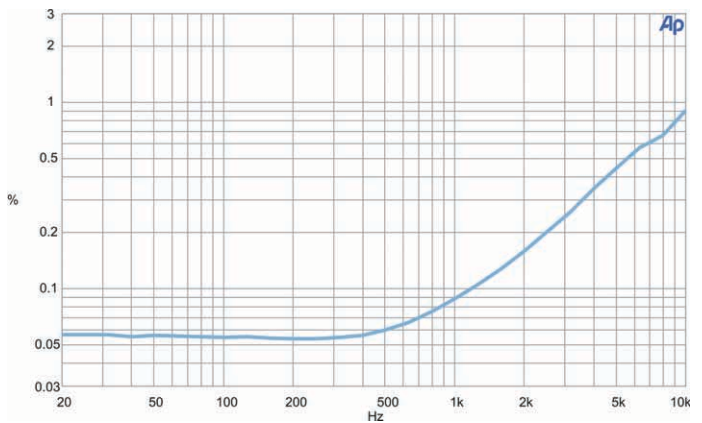

Figure 10. Sweep of THD+N (%) versus Frequency of the same amplifier as shown in Figure 9 (Output power = 100 Watts).

Sweeps with too few data points can easily miss important detail. Figure 11 shows an expanded sweep of THD+N at low frequencies. In this particular test the ac mains frequency was 60 Hz. The notch filter sweeping over fixed hum products in the amplifier output causes the presence of dips at 60 Hz and 180 Hz in the THD+N curve. At the high end of the audio band, expanded sweeps of THD+N near the major sub-harmonics of the amplifier's switching frequency could reveal pulse width modulator problems. For example, if a switch-mode amplifier operates at 250 kHz, it might be very interesting to conduct expanded THD+N sweeps around 20.83 kHz (250k/12), 19.23 kHz (250k/13), etc.

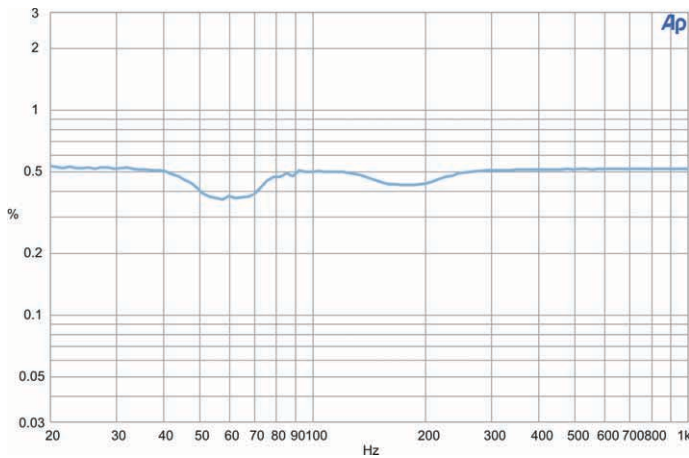

Figure 11. Expanded sweep of THD+N versus Frequency showing the effects of significant hum products, at 60 Hz and 180 Hz.

3.3 Maximum Output Power

The maximum output power at any given frequency is usually measured by increasing the amplitude until THD+N equals 1%. The typical limiting mechanism is clipping that causes THD+N to increase abruptly over a relatively small change in amplitude. Some amplifier designs employ signal dependent compressors that act to reduce the gain of the amplifier in response of signal amplitudes above a predetermined threshold. Since this type of limiting avoids clipping, THD+N may never reach the 1% point. Thus an alternative definition of maximum output power is the point where compression equals 1 dB.

Maximum output power will usually vary only modestly as a function of frequency in most good amplifier designs. Power supply sag and ripple voltage effects typically result in a slightly lower power capability at frequencies below about five times the ac mains. The output LC filter can contribute power losses at higher frequencies. Compressor limited designs may also introduce frequency dependent effects.

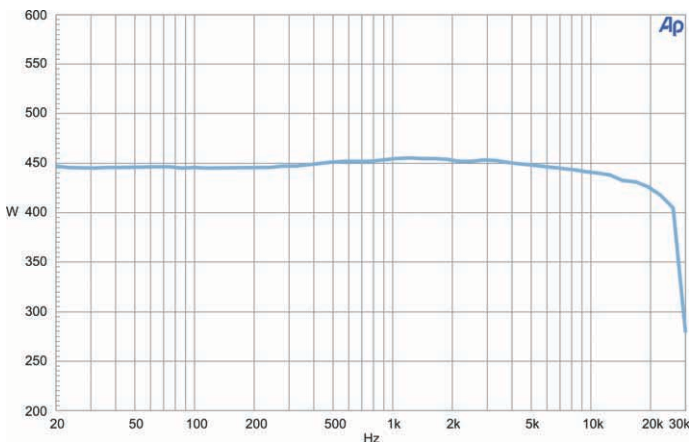

Figure 12. Sweep of maximum output power versus frequency for a typical switch-mode amplifier.

Some audio analyzers provide the capability of “servoing” signal amplitude to achieve a desired measurement value. This allows maximum output power to be plotted versus frequency so long as a compressor is not present. Figure 12 shows a typical graph.

3.4 Dynamic Headroom Measurements

Dynamic Headroom is the ratio of the maximum power output level of a 20 ms burst of a sine wave at the clipping point of the amplifier to the Power Output Rating of the amplifier. The Power Output Rating of an amplifier is the minimum sinewave power output in watts that can be delivered into an 8 ohm load at 1 kHz at no more than 1% THD. This is a method of determining the reserve ability of a power amplifier to deliver short bursts of power as would typically be encountered with music material. The test signal is a 20 ms burst followed by a 480 ms sinewave 20 dB below the clipping point repeated twice a second.

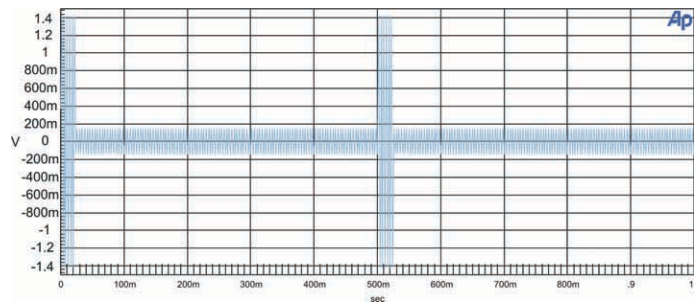

Figure 13. Burst signal used for Dynamic Headroom test.

3.5 FFT Analysis of Harmonic Distortion

One of the strongest advantages of a THD+N measurement is also its big weakness. A single THD+N figure conveys *no* information about the *nature* of a device’s imperfection because it weights all signal components within the prescribed bandwidth equally. An isolated 1% reading could just as easily result from 1% power supply hum, 1% second harmonic distortion, or 1% of a beat frequency product from the non-linear mixing of a high order test signal harmonic and the amplifier’s switching frequency. Investigating THD+N versus amplitude and frequency can help sort out some of these contributions, but it gives an incomplete picture. It also does not address the issue of audibility.

FFT analysis can provide this additional insight. Displaying the spectrum of the measured THD+N gives a complete picture. Distortion can easily be identified as harmonic or non-harmonic. Distortion can further be quantified by its order. Third harmonic (3HD) distortion is commonly believed to be more audibly offensive than an

identical amount of second harmonic (2HD) distortion. Non-harmonic products are easily identifiable.

There are two basic ways to display distortion spectra. The most common technique is to perform the FFT on the input signal directly. The spectrum is easy to interpret, but it will be limited by the -100 dB to -110 dB residual distortion performance of the analyzer's A/D converter.

It is also important to understand the limitations of the FFT window function. Many windows have "side-lobes" that can prevent an accurate distortion measurement, especially at low frequencies. Figure 14 shows a comparison of some of the more commonly used windows taken with the signal located exactly between two bins for maximum leakage. The Audio Precision "Equi-Ripple" window features side lobes of -150 dB or less.

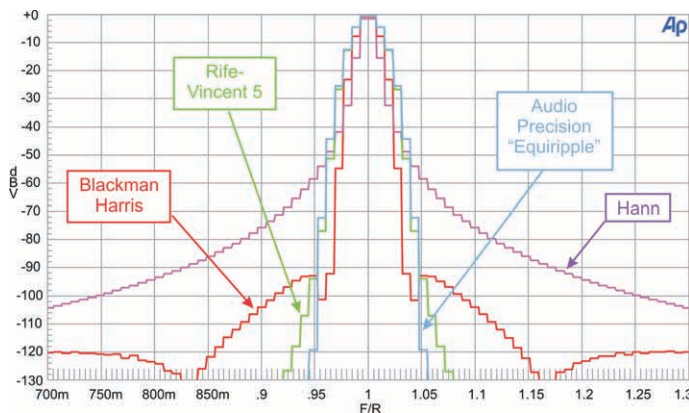

Figure 14. Comparison of some of the more popular FFT windows.

If lower residual performance is required, the audio analyzer can be set to display the FFT of the signal following the analog notch filter used for THD+N measurements. With the fundamental attenuated by the notch filter, the distortion contribution of the A/D converter ceases to be a limitation. This greatly extends the dynamic range of the FFT because a considerable amount of gain can be added to the measurement signal path following the notch filter. The residual distortion performance of state-of-the-art audio analyzers such as the Audio Precision models SYS-2622, SYS-2712, and SYS-2722 is typically in the range of -120 dB to below -140 dB using this technique.

Figure 15 shows FFT spectra taken using both techniques. The characteristic dip in the noise floor around the attenuated fundamental frequency easily identifies the spectrum taken with a notch filter present.

3.6 THD versus THD+N

The various harmonics revealed in an FFT display can be rms summed to give a "THD-only" reading. However, there is debate over how many harmonics to include in a THD measurement. Some define THD to include only harmonics 2 through 5. Others prefer to sum all harmonics through the 10th or even 15th order. Still others suggest summing all visible harmonics within the measurement

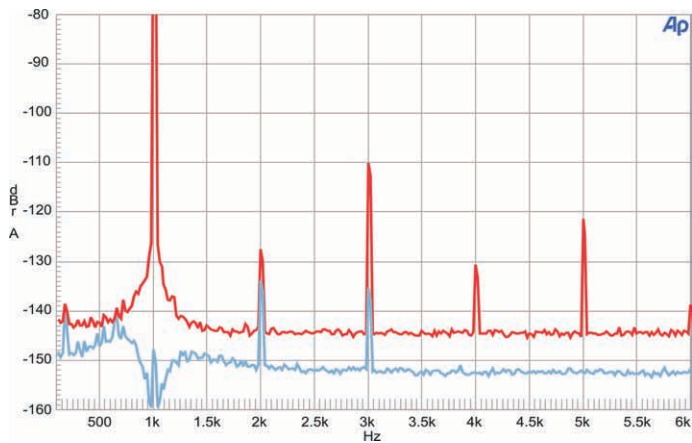

Figure 15. THD+N spectrum taken using two different techniques. The red curve shows the spectrum taken directly from the input signal. The blue curve shows the spectrum taken from the output of the analog notch filter.

bandwidth no matter what the order. Low frequency THD is subject to additional problems in definition. For example, is it correct or incorrect to include the 60 Hz and 120 Hz hum products of North American ac mains in a 20 Hz THD measurement?

The Audio Precision "Harmonic" DSP program provides automatic THD measurements up through the 15th order or the Nyquist bandwidth limitation imposed by the converter sample rate. It additionally provides the capability to sum any arbitrary combination of harmonics such as just the even order, or just the odd order. THD measurements are less sensitive to noise than THD+N measurements and, thus, advantageous at low signal levels. However THD+N still affords the lowest residual distortion performance because the analog notch filter effectively removes the A/D converter contribution.

4.0 Intermodulation Distortion Measurements

Intermodulation Distortion (IMD) is a measurement of non-linearity in response to two or more signals. There are an infinite number of IMD tests one can perform by varying the test tone frequencies, number of test tones, amplitude ratios, and even the waveforms. All share the basic premise that a non-linearity will cause the introduction of undesirable mixing or intermodulation products that were not present in the original test signal.

Some believe IMD measurements correlate better with audible quality than THD+N or THD figures. The argument made is that IMD products typically have no harmonic or musical relationship with the original test tones, thus they will tend to be more audible and psychologically obnoxious. Although this debate may never be resolved due to its subjective nature, there can be no disagreement that certain forms of IMD testing will reveal non-linear behavior that is otherwise not measurable using conventional THD+N or THD techniques.

4.1 SMPTE or SMPTE/DIN IMD Measurements

Perhaps the most popular of all IMD tests is “SMPTE” or “SMPTE/DIN”. This test finds its origins many decades ago in the testing and quality control of optical sound tracks on cinema film. The basic concept of SMPTE IMD testing is to look for the presence of amplitude modulation of an HF tone in the presence of a stronger LF tone. If a film print is either under or over exposed, SMPTE IMD dramatically increases.

SMPTE IMD is widely used in power amplifier testing. Testing for AM modulation of an HF tone in the presence of a larger LF tone provides an exquisite test of matching in push-pull vacuum tube designs. Measuring SMPTE IMD provides a good way to optimize the output stage bias adjustment for minimum crossover distortion in Class AB designs.

The most commonly used test signal is a combination of 60 Hz & 7 kHz mixed in a 4:1 amplitude ratio, but there are distinct national preferences. In Europe it is common to use the DIN Standard frequencies of 250 Hz & 8 kHz. In Japan one frequently encounters 70 Hz as the low-frequency tone. 70 Hz has the advantage of not being related to either 50 Hz or 60 Hz ac mains (both of which are found in Japan). In applications such as telephony involving very narrowband audio, another variation is to use 300-500 Hz for the lower tone and 3 kHz for the upper tone. These recipes are all basically the same and give similar results.

SMPTE IMD analyzers typically operate by removing the LF tone with a suitable high pass filter, then performing amplitude de-modulation of the left over HF tone. In the frequency domain this is equivalent to measuring the AM sidebands of the HF tone. Using the tone combination of 60 Hz and 7 kHz as an example, SMPTE IMD products will appear at 7000 ± 60 (6940 and 7060), 7000 ± 120 (6880 and 7120), etc.

Historically, SMPTE IMD results are expressed in terms of the amplitude modulation percentage of the HF tone. This can lead to some confusion when interpreting FFT displays. A 100% AM modulated signal theoretically contains a pair of equal amplitude sidebands that are 6.02 dB below the HF carrier, not 0 dB! It is also important to note that frequency domain modulation sidebands surrounding the HF tone can result from both AM or FM modulation. Without additional phase information, it is impossible to deduce the nature of modulation when viewing a standard magnitude-only FFT display. Thus SMPTE IMD measurements attempted directly from an FFT may not correlate very well with a true SMPTE IMD analyzer reading.

Figure 16 shows a typical sweep of SMPTE IMD versus output power. Note the similar shape to the Figure 9 curve for 1 kHz THD+N. SMPTE IMD in switching amplifiers is usually a measure of the linearity of the pulse width modulator.

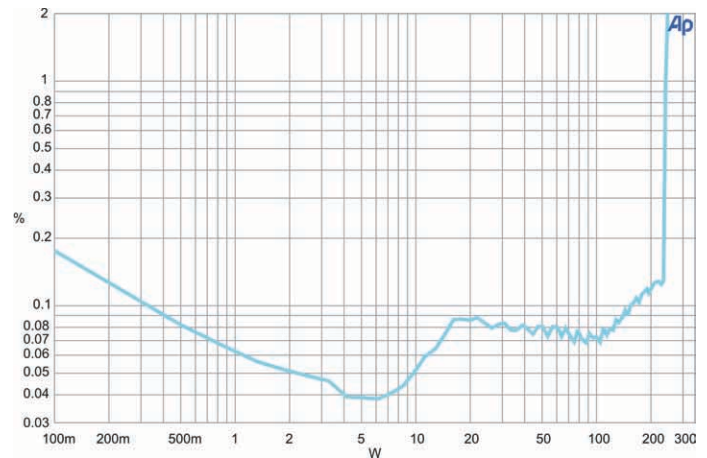

Figure 16. Sweep of SMPTE IMD versus Amplitude for a typical switch-mode amplifier. Note the similarity in shape with THD+N in Figure 9.

4.2 Twin-Tone IMD Measurements

“Twin-Tone” IMD tests are usually characterized by a test signal with equal amplitude sine waves spaced relatively close together in frequency. The big advantage to this form of distortion testing is that high frequency non-linearity can be explored in a sharply bandwidth-limited system that would otherwise be impossible to quantify using THD or THD+N techniques. THD or THD+N testing will simply fail to reveal any useful information about the distortion of a system if the distortion products fall outside of the system’s bandwidth, even if the non-linearity is severe. Many of the non-linear IMD products fall in-band with twin tone testing, where they can be measured without significant attenuation or error.

For full range (>20 kHz bandwidth) amplifiers, Audio Precision recommends testing with a combination of 18 kHz and 20 kHz tones. The second order IMD product will appear at 2 kHz, the third order products at 16 kHz & 22 kHz, the fourth order product at 4 kHz, the fifth order products at 14 kHz & 24 kHz, etc. The 2 kHz separation of IMD products using this combination of test tones gives an easy to interpret FFT display. For more limited bandwidth systems such as sub-woofer amplifiers, the test tone frequencies can be scaled as required.

The twin tone test is arguably very severe, but it is also one of the most revealing. Even order IMD products (e.g. 2 kHz) indicate an asymmetrical form of non-linearity, i.e. one that is polarity dependent. Odd order IMD products indicate a symmetrical form of non-linearity. One of the most insidious sources of odd order IMD in a switch-mode amplifier can occur in the output LC filter. The inductor can exhibit considerable non-linearity if manufactured with an iron or ferrite core.

Figure 17 shows an interesting twin-tone IMD spectrum near maximum output of a switch-mode amplifier. Besides the gross distortion products at 16 kHz and 22 kHz, note the hum sidebands surrounding the two test tones at 18 kHz and 20 kHz.

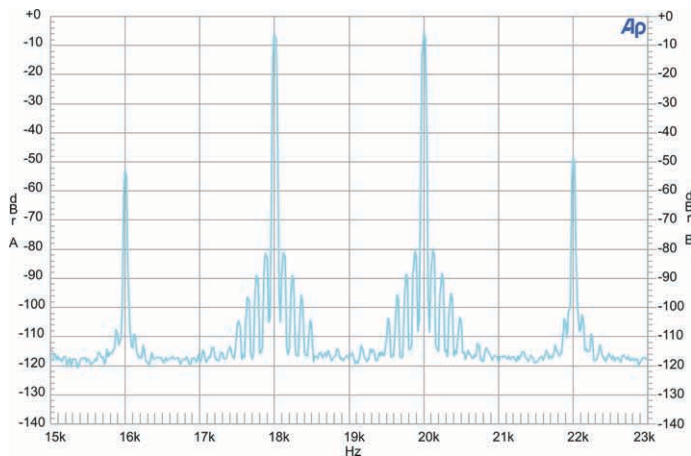

Figure 17. Twin tone IMD of a low quality switch-mode amplifier showing very high odd order distortion products. Also note the presence of hum sidebands surrounding the two test tones at 18 kHz and 20 kHz.

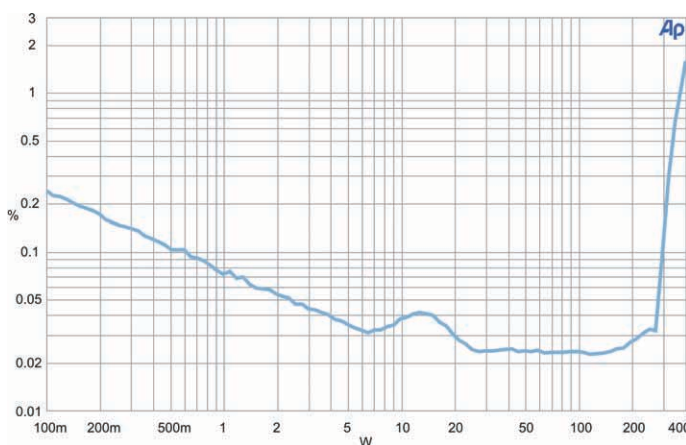

Figure 18. Sweep of DIM30 IMD versus Amplitude for a typical switch-mode amplifier.

4.3 Dynamic or Transient IMD Measurements

DIM/TIM testing originated in the early to mid 1980s in response to concerns about amplifier linearity during the fast slewing portions of a complex signal. The test signal is an unusual combination of a bandwidth limited 3.15 kHz square wave and a 15 kHz “probe” sine wave mixed in a 4:1 peak-peak amplitude ratio. IEC-268 defines 9 specific IMD products to be measured in a spectral display. Some audio analyzers implement a simplified version of this test that was first proposed by Paul Skritek in which only 2 of the 9 IMD components that happen to fall below the frequency of the square wave are measured. The simplified test offers improved dynamic range because the test signal square wave and sine wave components can be successfully removed using a sharp low-pass filter leaving only the two lowest IMD components to be measured.

Two versions of the test are generally recognized. The square wave is bandwidth limited to 30 kHz in the “DIM30” test and 100 kHz in the “DIM100” test with 1-pole roll off filters to prevent excessive signal slew rates. [The audio industry realized years ago there are reasonable slew rate limitations to be expected in audio signals!] The DIM100 test signal contains a peak slew rate that is about 3.3 times that of a DIM30 test signal having the same amplitude. DIM/TIM testing is no longer as common as it once was because amplifier designs quickly evolved to favor lower overall feedback factors and attention to more linear behavior before the application of feedback. Switch-mode amplifiers inherently have more complex bandwidth and stability considerations that make the use of large amounts of feedback trickier to implement.

Figure 18 shows the results of a simplified DIM30 test versus amplitude for a typical switch-mode amplifier. Note the absence of significantly rising distortion prior to the abrupt clipping point, thus indicating very little or no significant presence of DIM.

5.0 Frequency Response and Phase Measurements

Switch-mode amplifier response and phase measurements should always be made with a test load and suitable low-pass filter such as the Audio Precision AUX-0025 to prevent the input stage of the analyzer or DVM from potentially reacting non-linearly to the fast slewing switching artifacts. It may seem logical to perform these measurements without the filter to avoid its own errors. However, any analyzer errors caused by an input stage non-linearity are likely to be complex functions of both amplitude and frequency, not to mention temperature and other subtle test conditions.

Response is usually displayed in relative dB units (“dBr”) with 0 dB corresponding to the output at 1 kHz. In most cases response should be measured over the full audio range of 20 Hz to 20 kHz at a level that is well below maximum. Measuring response near full output can lead to errors with amplifiers that employ anti-clipping compressor circuits. These circuits usually have frequency dependant attack and decay characteristics that will seriously affect the validity of a swept single sine wave response measurement. Multi-tone techniques should be employed to investigate flatness under these circumstances.

Under most conditions the sharp bandwidth limiting filter (“S2-AES17”) should be disabled when making response or phase measurements. This is absolutely necessary when looking at the amplifier’s high frequency roll off characteristic. Investigations of high frequency roll off should always be done at multiple output levels. Some amplifier pulse width modulator designs may exhibit interesting amplitude dependent frequency response characteristics.

Figure 19 shows the frequency response taken unloaded (blue trace) and with an 8 Ω load (red trace)

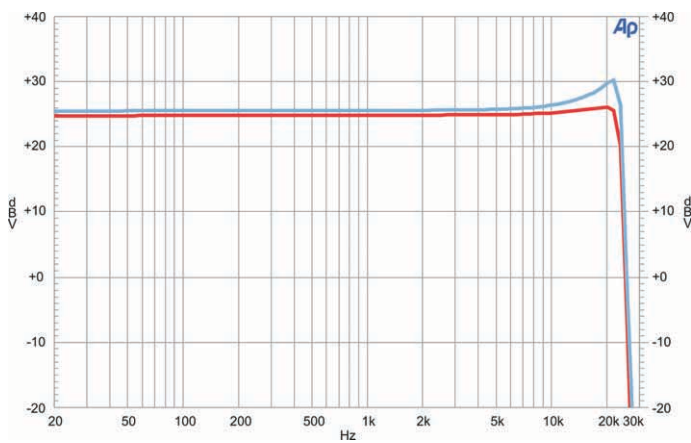

Figure 19. Frequency response of a typical switch-mode amplifier.

Measurements of inter-channel phase need little consideration. The differential phase error between the two channels of the AUX-0025 accessory is typically <2 degrees over the entire audio bandwidth. However, measurements of amplifier input-output phase will definitely require correction. The AUX-0025 introduces about 41 degrees of phase shift at 20 kHz (see Figure 20 for typical phase shift characteristic).

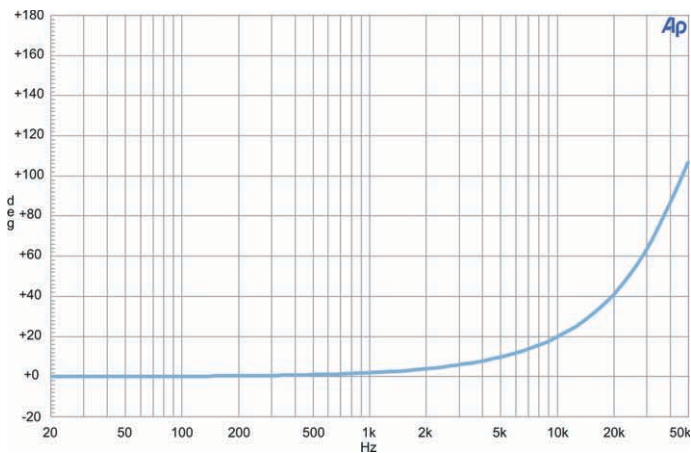

Figure 20. Typical input/output phase shift introduced by the Audio Precision AUX-0025 filter accessory.

6.0 Crosstalk Measurements

Crosstalk measurements of multi-channel switch-mode amplifiers are very similar to conventional amplifiers. A signal is inserted into one (or all but one) channel while the output of the remaining channel is measured. For valid measurements the un-driven channel(s) must be terminated and the gain settings in both channels must be equal. Audio Precision recommends the use of its sharp bandwidth limiting option (the “S-AES17”) to prevent ultra-sonic noise from potentially contaminating crosstalk readings near the upper end of the audio band.

Crosstalk should be measured as a function of signal frequency. Capacitive coupling and mutual inductance effects typically cause crosstalk to degrade with increasing frequency. Crosstalk also tends to be very channel dependant, and it must be measured both ways in a stereo amplifier.

The mutual inductance between the interconnections of the amplifier outputs and test loads can be a serious source of measurement error. Audio Precision recommends using twisted pairs for each output connection, and keeping them separated from each other. The test loads themselves can be another source of error. Whenever possible, they should be constructed of non-inductive power resistors and positioned for minimum coupling between channels.

Figure 21 shows the crosstalk characteristics for a typical switch-mode amplifier.

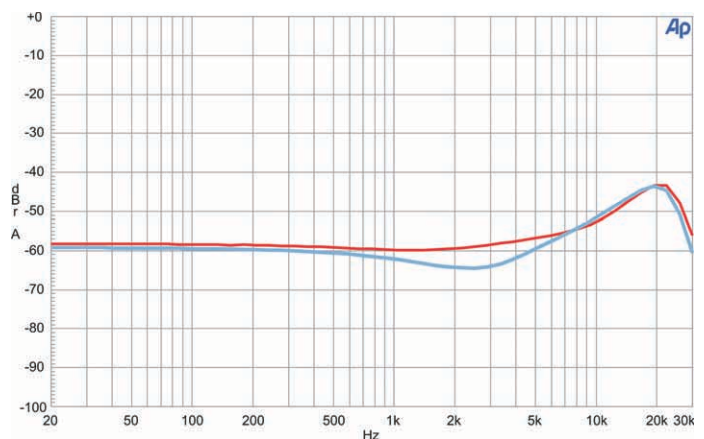

Figure 21. Crosstalk versus Frequency for a typical switch mode amplifier. The red curve shows the Channel A into Channel B characteristic. The blue curve shows the reverse.

7.0 Damping Factor Measurements

Damping Factor is the ratio of the rated load of an amplifier to the actual output (source) impedance of the amplifier. It is a measurement of the amplifier’s voltage regulation; the higher the damping factor, the lower the output impedance of the amplifier, and the better the regulation.

Damping factor is important because the typical load to a power amplifier, a speaker, has an impedance that is not constant with frequency. If the impedance of a loudspeaker were purely resistive and constant across frequency, damping factor would be of little significance. But the impedance of a speaker will indeed vary with frequency, particularly near the natural resonance frequency of the speaker. If the output impedance of the amplifier is significant, as indicated by a low damping factor, the effective drive capability of the amplifier into the speaker will change with frequency. This will show up as a variation in effective frequency response.

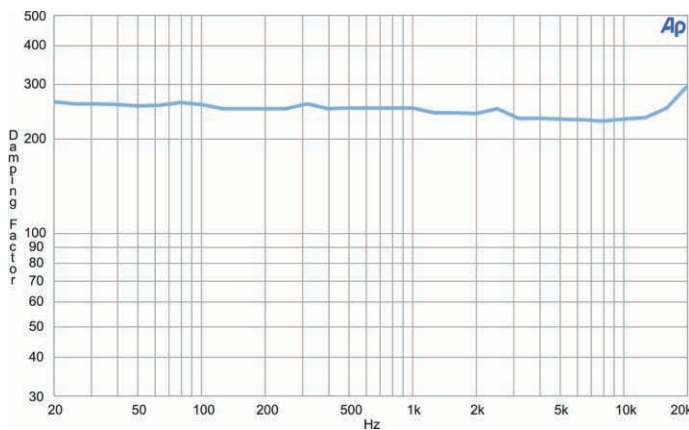

Figure 22. Damping Factor vs Frequency

Lower damping factors will also affect how well an amplifier can “control” a speaker. In actual operation with music or other program material being amplified by the power amplifier, the speaker cone will be moving in response to this signal. With every new signal value, the amplifier attempts to move the cone to a new position. Its ability to do this is largely dependant on how much power it can develop and this in turn by how much current it can produce at a particular instant. This is set by the capacity of the power supply, the output impedance of the amplifier, and even the resistance of the speaker connection wires. Audiophiles frequently debate this issue but it is common to see recommendation suggesting damping factors more than 50 or 100 are desired in a high-quality amplifier.

Power amplifier output impedance can typically vary over frequency so a common measurement is to plot damping factor versus frequency. Figure 22 is an example of damping factor versus frequency.

8.0 Supply Rejection Measurements

Power supply rejection measurements are typically more relevant for ICs and functional assemblies that are intended to operate from dc sources. In many respects a supply rejection measurement can be viewed as a special type of crosstalk measurement. Conceptually, a test signal is imposed in series with the target dc supply while the amplifier output is examined for presence of the signal. Supply rejection is usually expressed as a dB ratio in the form of a graph versus test signal frequency.

Connecting a test signal generator in series with a power supply can create some major problems. First, the power supply current drawn by the amplifier must flow through the output of the ac signal generator. The output impedance of most sine wave or function generators is likely to cause unacceptable voltage drops. Second, very few generators can be electrically floated to the power supply potential. One common solution is to use a small signal transformer to couple the ac test signal in series with the power supply

connection. The transformer must be selected to provide a suitably low dc impedance with enough dc current handling capacity to prevent core saturation. The reflected ac impedance can be quite low if the transformer primary to secondary turns ratio is large. However, transformer bandwidth usually is severely compromised for turn ratios other than unity. Another technique to obtain low ac impedance is to insert an attenuator in series with the signal generator output and a unity gain transformer.

Traditional power supply rejection measurements look for an output signal at the same frequency as the signal being injected into the supply. However switch-mode amplifiers present the possibility of intermodulation between the applied supply test signal and the switching frequency components. For example, if the switching frequency of a given amplifier is 500 kHz, a 501 kHz supply component may show up in the output as a 1 kHz or 501 kHz signal. Inadequate supply decoupling can lead to audible “birdies” in multi-channel amplifiers sharing a common raw supply if the switching frequencies are not locked to each other.

9.0 Efficiency Measurements

Power amplifier efficiency is ratio of delivered output power to the input power drawn from the ac mains or dc supplies. Efficiency is usually measured with a 1 kHz test signal. Lower frequency test signals can lead to different results due to the complex interactions with the ac mains frequency inside the raw supplies. Efficiency is also likely to decrease at higher frequencies due to non-reactive losses in the output LC filter.

Figure 23 shows a typical setup for measuring amplifier efficiency. If the amplifier is designed to operate from dc sources, input power can be measured by taking the product of the supply voltage and current measurements. Current can be measured directly or indirectly as a voltage drop across a known small resistor. If the amplifier operates from ac mains, measuring the input power poses a more significant challenge. There is simply no good substitute for a true power meter. The numerical product of an ac mains voltage and current measurement does not give power; it gives “VA”.

Output power can be accurately determined from an rms voltage measurement because the load is a resistance. Many audio analyzers allow level readings to be displayed in units of “Watts” based upon a calculation using an assumed value for load resistance. Because the AUX-0025 introduces a slight 0.05 dB insertion loss, input voltage readings will be about 0.6% low. This will cause calculated power readings to be 1.2% low. For graphical purposes this error is not likely to be noticed. If the analyzer allows arbitrary entry of the assumed load resistance value, the insertion loss error is easy to correct. Simply enter a load resistance that is 1.2% lower than the actual load. For example, a resistance value of 7.90Ω should be entered to correct power readings if the test load is 8.00Ω. Similarly use 3.95Ω or 1.98Ω if the test load is 4.00Ω or 2.00Ω respectively.

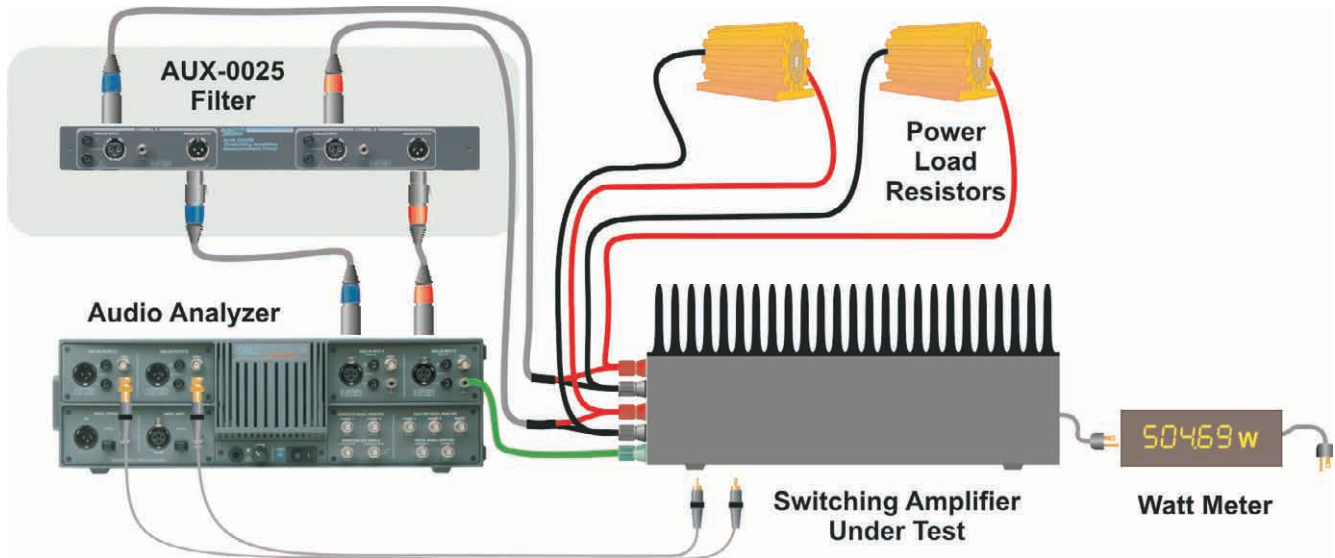

Figure 23. Recommended setup for measuring amplifier efficiency.

If the input power measurements can be automated, efficiency can be swept as a function of output power level. Be sure to allow sufficient time for power supply energy storage elements to reach equilibrium before taking measurements at each new power level. Power amplifier supplies can sometimes take several hundred milliseconds (tens of cycles of the ac mains) to reach input power stability. Extremely high power amplifiers may also have thermal effects that must be given sufficient time to settle. If efficiency must be checked below 1 kHz with ac powered amplifiers, be sure to pick a test tone that will not beat slowly against the mains frequency. This could cause unstable power readings that will never settle. For example, measuring efficiency using a 61 Hz test tone with 60 Hz ac mains is very likely to result in a strongly fluctuating ac power reading with a 1 second period (1 Hz beat).

efficiency near full output power that is characteristic of switch-mode amplifiers.

Summary

Switch-mode amplifiers offer significant power efficiency and size advantages. When properly designed, they can sport audio performance that rivals the very best of linear amplifiers. Measuring this performance can be very challenging due to the high slew rate artifacts that can be present in some amplifiers' output. A passive LCR filter such as the Audio Precision AUX-0025 is highly effective in eliminating measurement errors due to the inevitable slew rate limit effects within all audio analyzers.

Acknowledgements

The author thanks Duke Aguiar and Bill Rich for their contributions to some of the measurements shown here and Wayne Jones for his assistance in reviewing and formatting this report for publication.

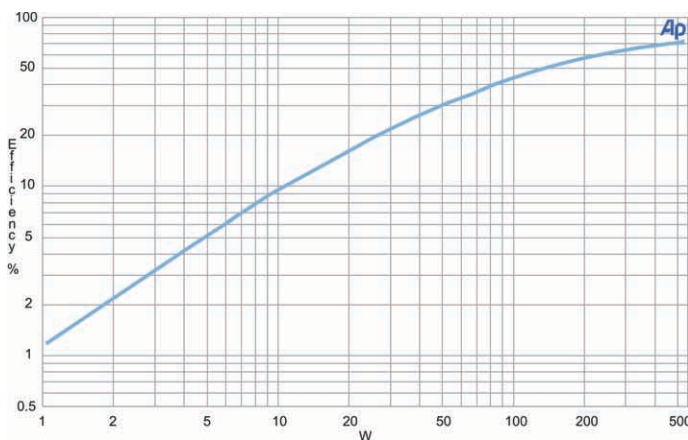

Figure 24. Efficiency versus Output Power for a typical switch-mode amplifier.

Figure 24 shows a typical sweep of amplifier efficiency at 1 kHz. Note the fairly broad range of relatively high

Useful References

Guidelines for Measuring Audio Power Amplifier Performance (Application Report SLOA068), R. Palmer, Texas Instruments, 2001.

EIA/CEA-490-A standard: *Testing and Measurement Methods for Audio Amplifiers*. Electronic Industries Alliance.

Audio Measurement Handbook, B. Metzler, Audio Precision, 1993.

Measurement Techniques for Digital Audio (Audio Precision Application Note #5), J. Dunn, Audio Precision, 2001.

AES Standard Method for Digital Audio Engineering—Measurement of Digital Audio Equipment (AES17-1991), Audio Engineering Society, 1991.

IEC60268-3, Part 3

A Comparison of Nonlinear Distortion Measurement Methods, R. Cabot, Audio Engineering Society Preprint 1638, 1980.

Simplified Measurement of Squarewave/Sine and Related Distortion Test Methods, P. Skritek, Audio Engineering Society Preprint 2195, 1985.

Practical Extended Range DIM Measurements, B. Hofer, Audio Engineering Society Preprint 2334, 1986.

Audio Precision website: audioprecision.com



Audio Precision Cascade Plus instrument with AUX-0025 signal conditioning pre-filter.

About the author...

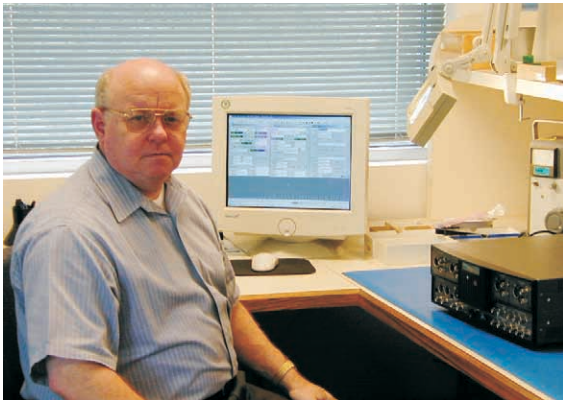

BRUCE E. HOFER

Bruce is one of the founders of Audio Precision and its principal analog design engineer. He remains technically active in spite of having recently become the company's majority shareholder and Chairman. Bruce's particular areas of design expertise include ultra-low distortion signal generation and processing, along with wideband linear signal amplification. Insiders have been known to call him the "precision" in Audio Precision because virtually every analog circuit in the company's product line bears his mark or influence.

Bruce's career with state-of-the-art instrumentation began in 1969. Prior to receiving his BSEE degree from Oregon State University in 1970, he was hired as an engineering assistant in the Lab Instruments Division of Tektronix under that company's summer student program. A year later he became a full-fledged engineer, and went on to design high-speed sweep generators and horizontal deflection amplifiers for Tek's famous 7000-series oscilloscopes.

In 1978 Bruce made a key career decision to respond to a growing personal interest in audio. He became the engineering manager and lead engineer of the Tek TM500 team that developed the world's first fully automatic distortion analyzer, the AA501 introduced in 1980. It was here that he also met or hired the other key team members that would ultimately leave Tektronix in 1984 to launch a new company called Audio Precision.

Bruce has received 12 patents and authored several articles and papers. He has made numerous presentations and served as a guest lecturer at Oregon State University and the Oregon Graduate Center. In 1998 Bruce was inducted into his alma mater's "Engineering Hall of Fame" as one of its relatively youngest members. He is also a member of the international Audio Engineering Society (AES), and received its Fellowship Award in 1995. Bruce is happily married and has two grown daughters.



Audio Precision
5750 SW Arctic Drive
Beaverton, Oregon 97005
Tel: 503-627-0832 Fax: 503-641-8906
US Toll Free: 1-800-231-7350
email: info@audioprecision.com
Web: audioprecision.com